



Product Name: AM-9 Series_15*15*4mm Active GNSS Antenna Module

Part Number: AM-9-A-N01

Features:

- 15*15*6.6mm Miniature Form Factor
- GPS & GLONASS L1 Bands Supporting
- 27dB LNA Gain, Exceptionally Low Noise Figure
- Up to 35dB Out-of-Band Rejection
- 1.13mm Mini-Coaxial with IPEX MHFI Connector
- Cable Length & Connector are customizable
- RoHS & REACH Compliant

Applications:

- Car Navigation
- Portable GPS Tracking
- Security Surveillance

15*15*4mm Active GNSS Antenna Module

MODEL: AM-9-A-N01

WI-RD-D-275 V1.0

© San Jose Technology, Inc.
All specifications subject to change without notice.

I. Specifications:

Category	Specifications	
Passive Antenna Performance		
Application Band	GPS	GLONASS
Frequency (MHz)	1575.42	1602
Efficiency (%)	34.32	30.25
Average Gain (dBi)	-4.64	-5.19
Peak Gain (dBi)	0.09	0.08
V.S.W.R	< 2	
Return Loss (dB)	< -10	
Test Condition	15.0 x 15.0 mm ² (Ground Plane Dimension)	
Impedance (Ω)	50	
Dimension (mm)	15(L) x 15(W) x 4(H)	
Polarization	R.H.C.P. (Right Handed Circular Polarization)	
Active Antenna Performance		
Frequency (MHz)	1575.42 ± 1.023	1602 ± 5
Gain (dB)	27.00	26.00
Noise Figure (dB)	1.18	1.14
Current Consumption (mA)	9.53 ± 2	
Output Impedance (Ω)	50	
GNSS_ Out of Band Rejection		
Frequency (MHz)	600~1520	1660~3000
Gain (dB)	37.00	41.00

ESD Protection	±8 KV (direct discharge) ±15 KV (air discharge)
Connector & Cable	
Connector	IPEX MHFI
Cable	1.13mm Mini-Coax
Length (cm)	2.5
Environmental Conditions	
Operation Temperature (°C)	-40~+85
Storage Temperature (°C)	-40~+85

II. Antenna Technical Parameters:

- **Passive Antenna Performace**

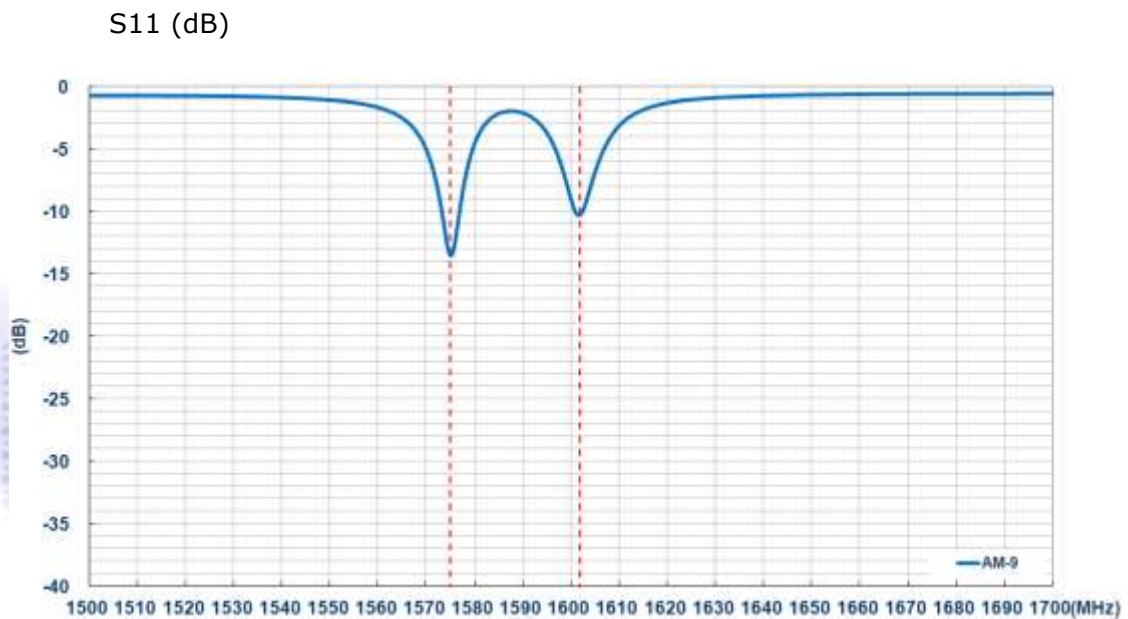

Efficiency (%)

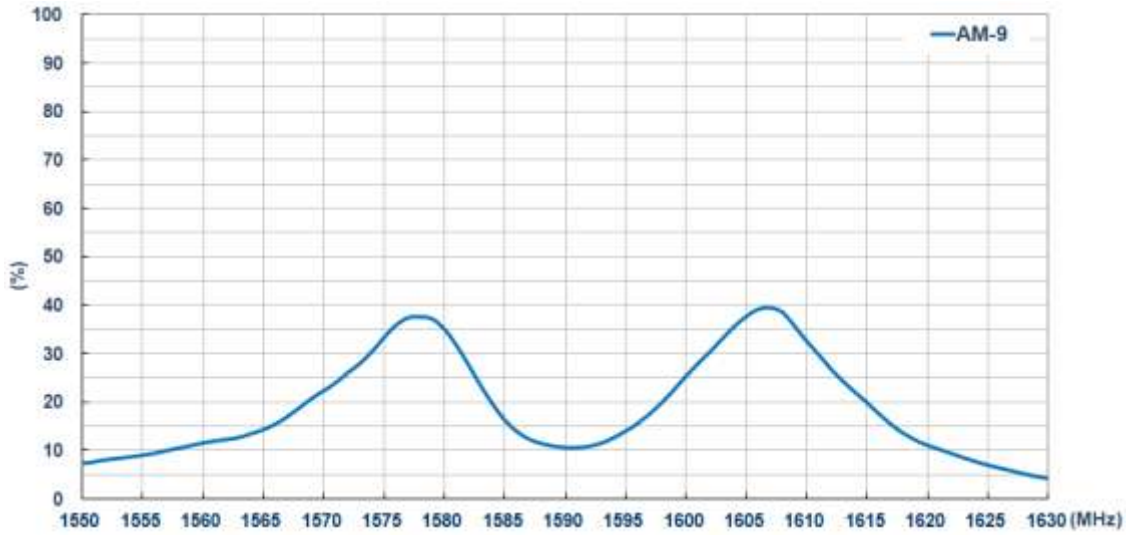

Average Gain (dBi)

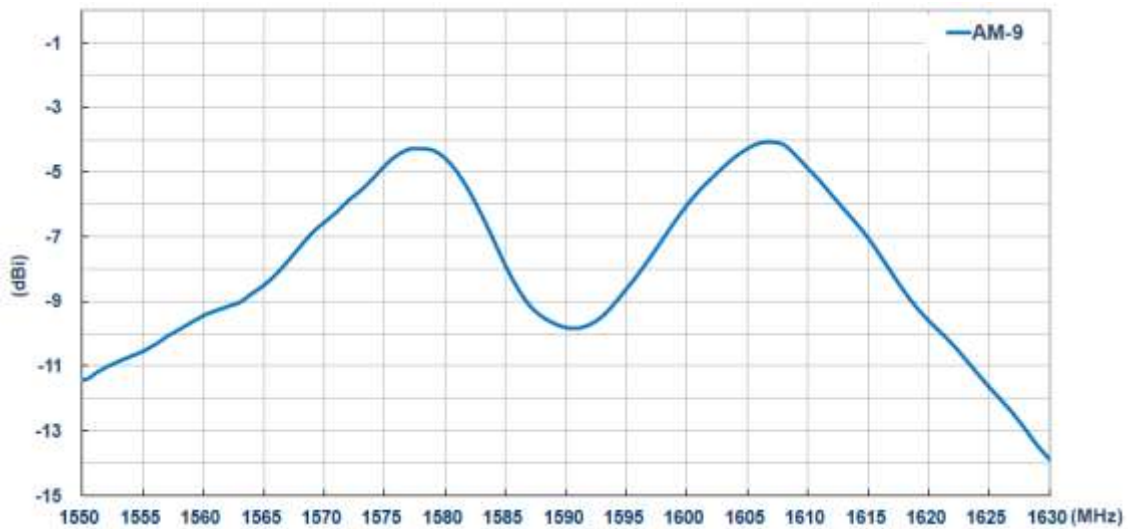

Peak Gain (dBi)

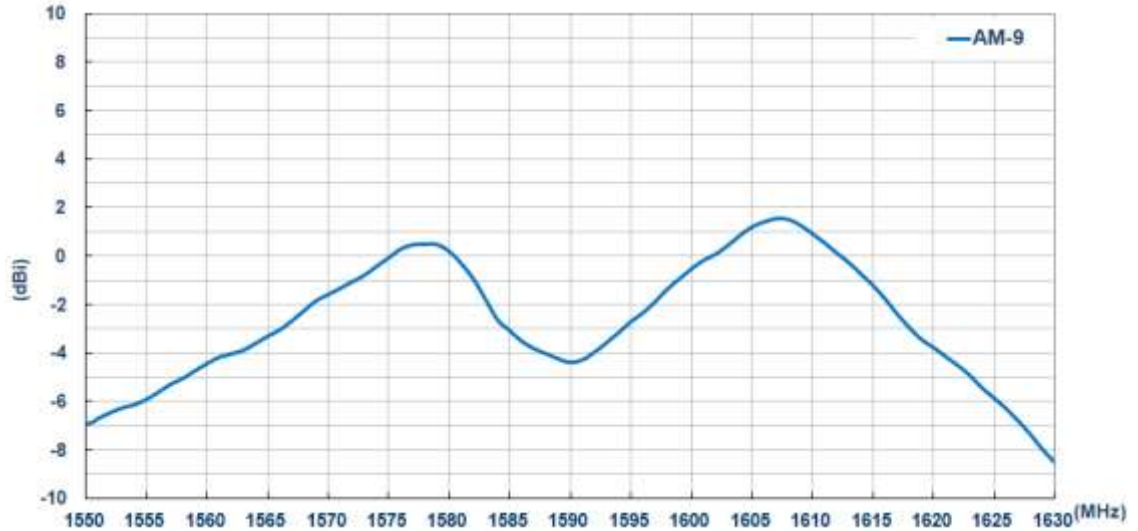

- **Active Antenna Performace**

Noise Figure & Gain (dB)

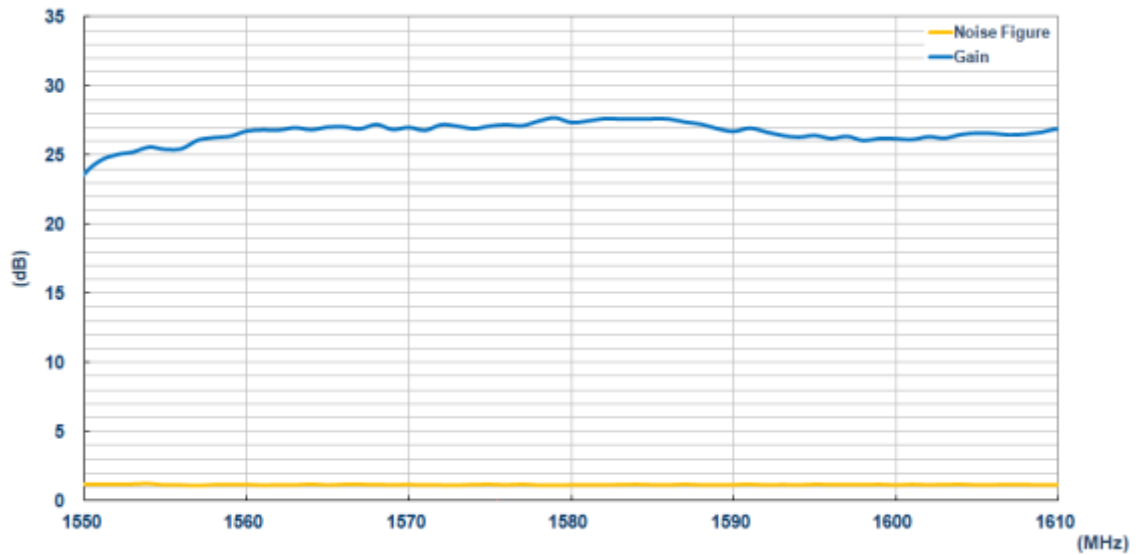

Out Of Band Rejection (dB)

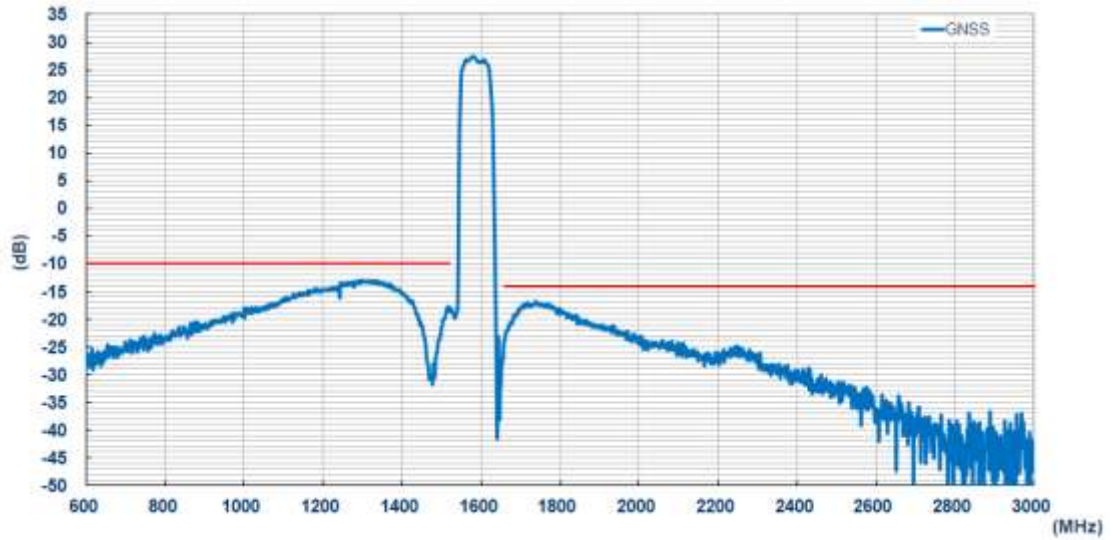

© San Jose Technology, Inc.
All specifications subject to change without notice.

III. Antenna Radiation Pattern Measurement:

The antenna radiation patterns were measured in ETS Anechoic Chamber. The measurement setup as below,

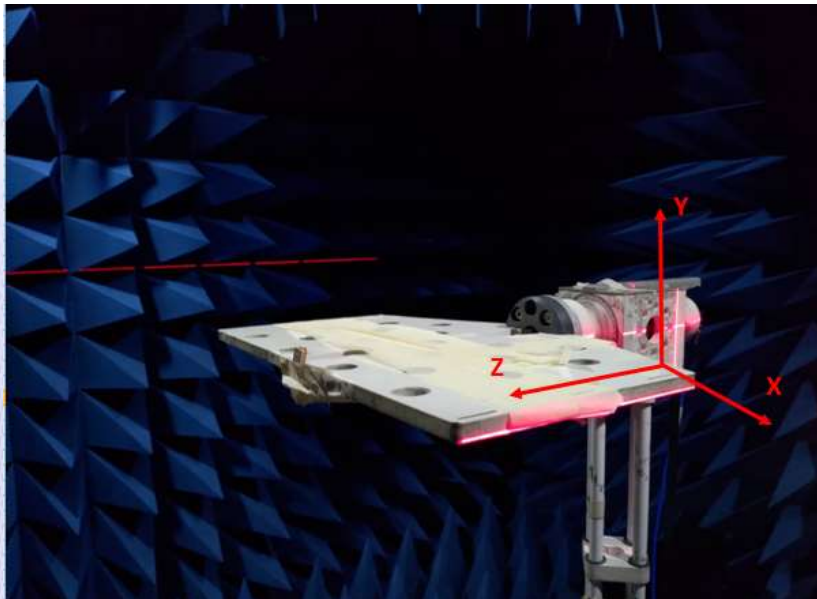

IV. 2D Radiation Pattern:

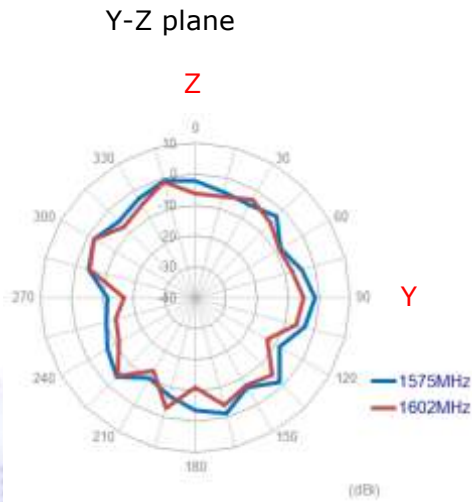
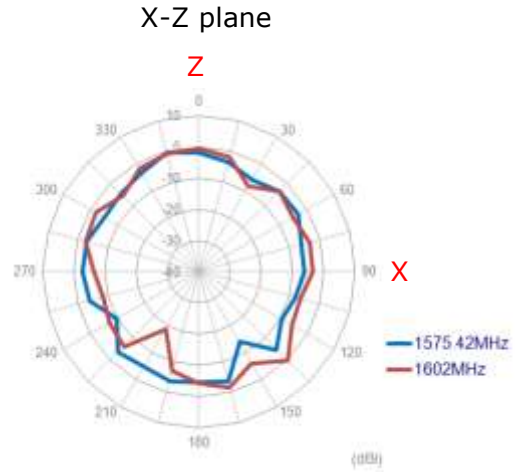
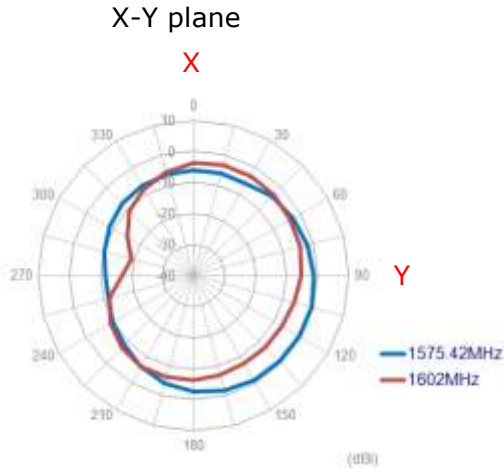

© San Jose Technology, Inc.
All specifications subject to change without notice.

V. 3D Radiation Pattern:

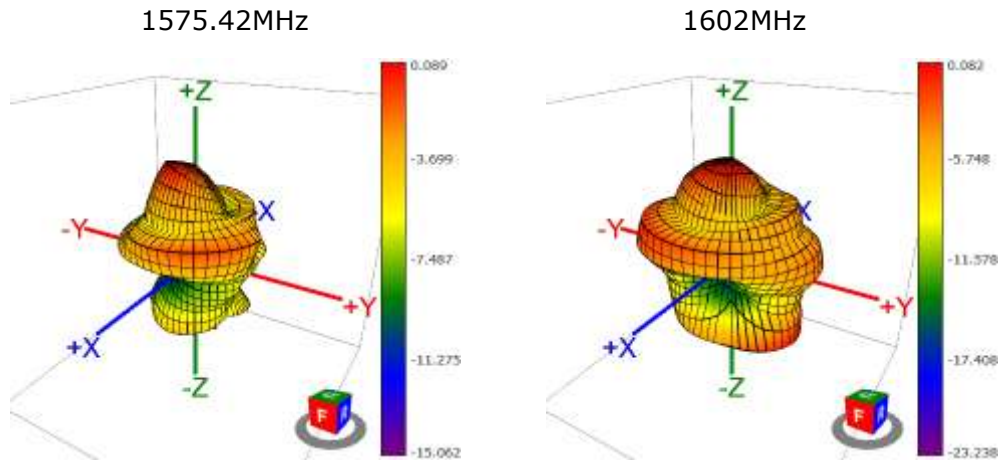

VI. Mechanical Drawing (Unit:mm):

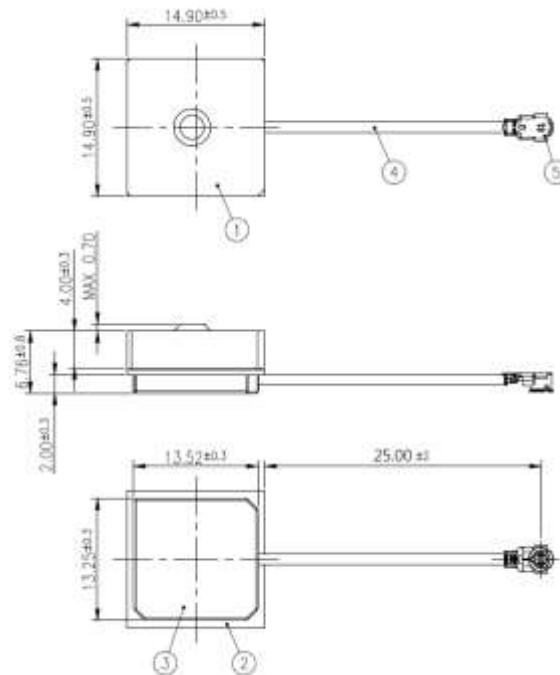

5	IPEX MHF(20278-112R-13)	Copper Alloy	Au Plated	1
4	OD1.13 Coaxial Cable	FEP	Black	1
3	AM-15 Shielding Case	SPTE	Natural	1
2	AM-15 PCB	FR-4	Green	1
1	AM-15G Patch	Ceramic	Clear	1
No	NAME	MATERIAL	FINISH	QTY